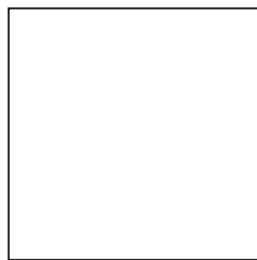

Questions? Call Disc Makers' Product Specialists at 1-800-468-9353.

**IMPORTANT NOTES:**

- Solid lines indicate trim, dotted lines are folds.
- Each document must include at least .125" bleed to ensure proper trim.  
(Except printing on CD itself.)
- Each document must have cut, fold, and registration marks.
- Keep type at least .125" from cut marks (safety margin).
- Release number must appear in each and every document.

- Drawings are not to scale!
- Measurements are in inches.

**One Page Insert**

4.75" x 4.75", trim

(5" x 5" includes  
.125" bleed  
on all sides)

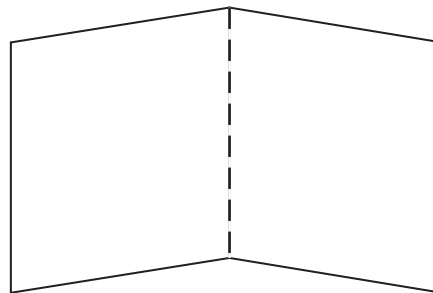
**Four Page CD**

9.5" x 4.75", trim

(9.75" x 5" includes  
.125" bleed top, bottom,  
and outside of panels)

**Tray Card**

5.9063" x 4.625", trim  
(spines are .25" each)

(6.1563" x 4.875"  
includes .125" bleed  
on all sides)

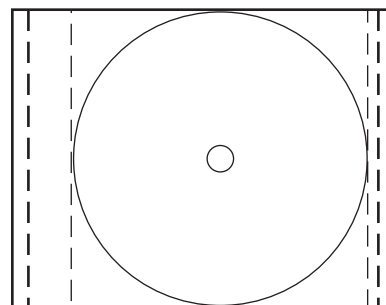
**Tray Card  
Inside**

*applicable only  
with clear tray*

This is the live area  
visible when CD is open –  
approx. 4.75".

This area shows through  
the front of CD,  
to the left of booklet –  
approx. .375".

Questions? Call Disc Makers' Product Specialists at 1-800-468-9353.

**IMPORTANT NOTES:**

- Solid lines indicate trim, dotted lines are folds.
- Each document must include at least .125" bleed to ensure proper trim.  
(Except printing on CD itself.)
- Each document must have cut, fold, and registration marks.
- Keep type at least .125" from cut marks (safety margin).
- Release number must appear in each and every document.

- Drawings are not to scale!
- Measurements are in inches.

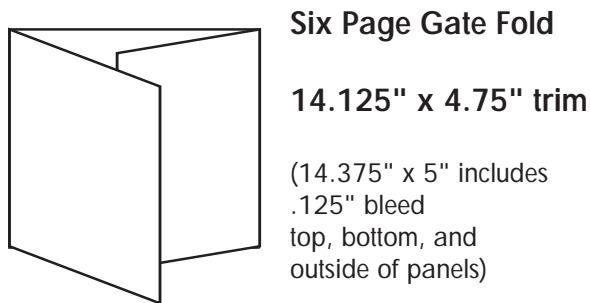

\*The backprinting for this template is the exact opposite

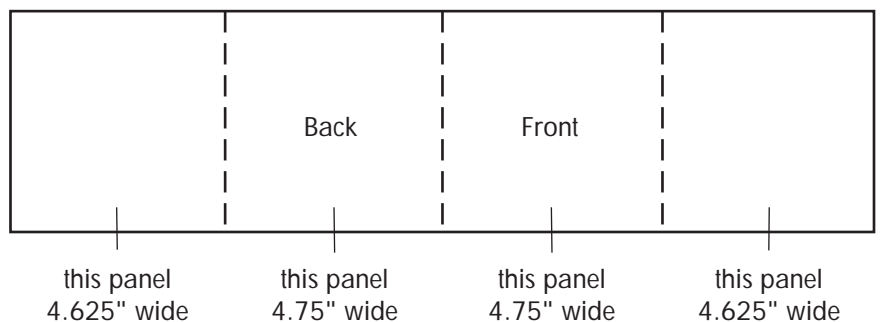
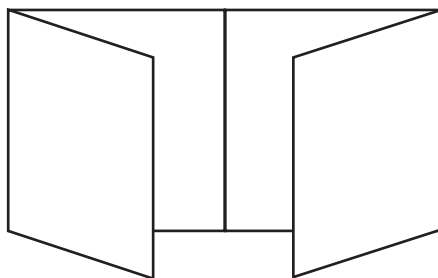
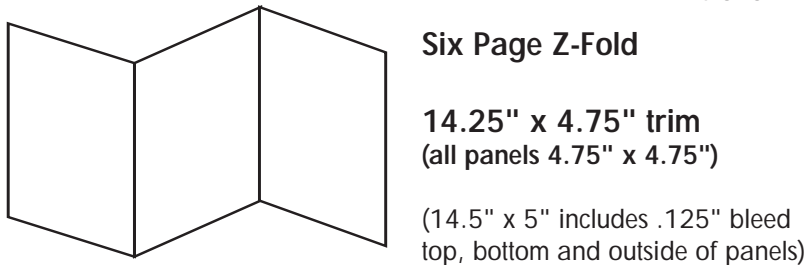
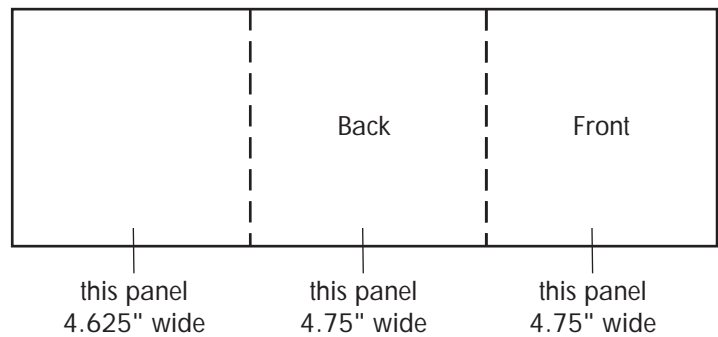
**Eight Page Gate Fold**

**18.75" x 4.75" trim** (19" x 5" includes .125" bleed top, bottom and outside of panels)

Questions? Call Disc Makers' Product Specialists at 1-800-468-9353.

**IMPORTANT NOTES:**

- Solid lines indicate trim, dotted lines are folds.
- Each document must include at least .125" bleed to ensure proper trim.  
(Except printing on CD itself.)
- Each document must have cut, fold, and registration marks.
- Keep type at least .125" from cut marks (safety margin).
- Release number must appear in each and every document.

· Drawings are not to scale!  
· Measurements are in inches.

**Eight Page Double Fold**

**18.9375" x 4.75" trim** (19.1875" x 5" includes .125" bleed top, bottom and outside of panels)

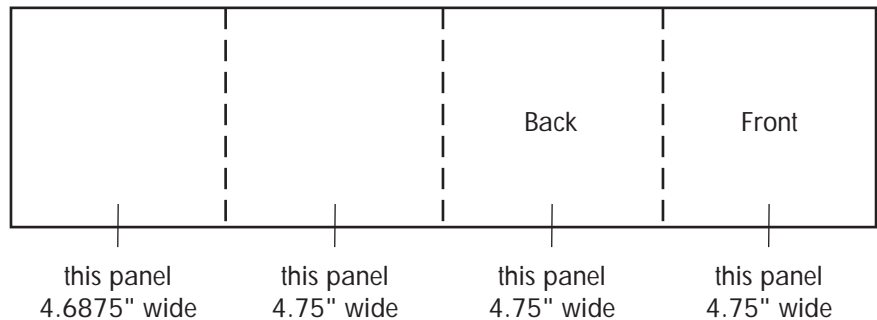
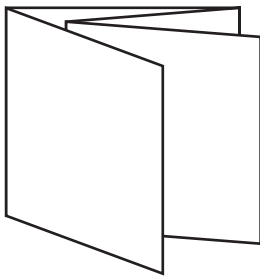
**Eight Page Accordion Fold**

**18.96875" x 4.75" trim** (19.21875" x 5" includes .125" bleed top, bottom and outside of panels)

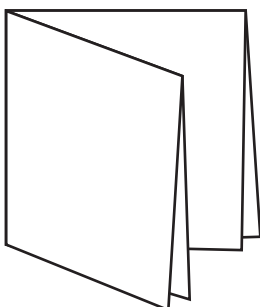
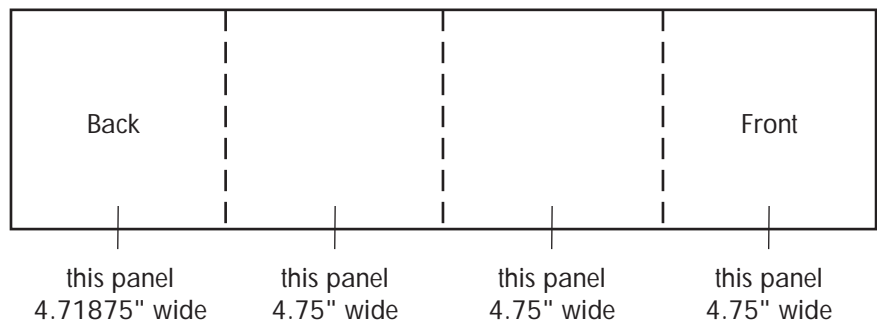
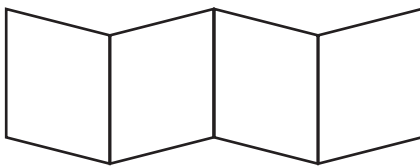
**Eight Page Poster Fold**

**9.5" x 9.5" trim**  
(all panels 4.75" x 4.75")

(9.75" x 9.75" includes .125" bleed  
top, bottom and outside of panels)

Questions? Call Disc Makers' Product Specialists at 1-800-468-9353.

**IMPORTANT NOTES:**

- All artwork and text must fit within specs -- NO BLEEDS!
- CD labels normally print in 2 PMS colors
- Maximum line screen is 85
- Smallest positive text is ( 4 POINT REGULAR OR BOLD)
- Smallest reverse text is ( 6 POINT BOLD)
- Label must include release number, CD logo, and center registration mark.

· Drawings are not to scale!

· Measurements are in millimeters, NOT inches.

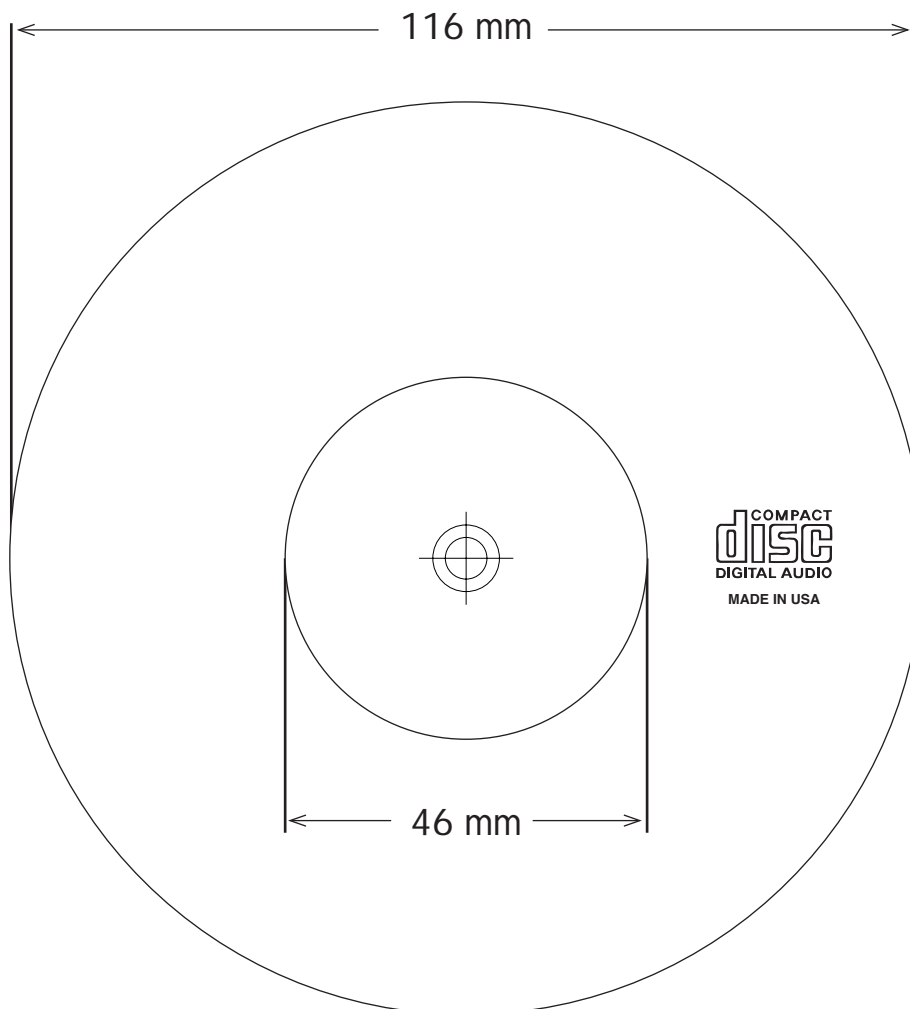
**CD Label  
Regular Template**

Questions? Call Disc Makers' Product Specialists at 1-800-468-9353.

**IMPORTANT NOTES:**

- All artwork and text must fit within specs -- NO BLEEDS!
- CD labels normally print in 2 PMS colors
- Maximum line screen is 85
- Smallest positive text is ( 4 POINT REGULAR OR BOLD )
- Smallest reverse text is ( 6 POINT BOLD )
- Label must include release number, CD logo, and center registration mark.

- Drawings are not to scale!
- Measurements are in millimeters, NOT inches.

**CD Label**  
**Print to Center Template - Universal**

Printable areas are from 116 to 38 mm, 32 to 25 mm.

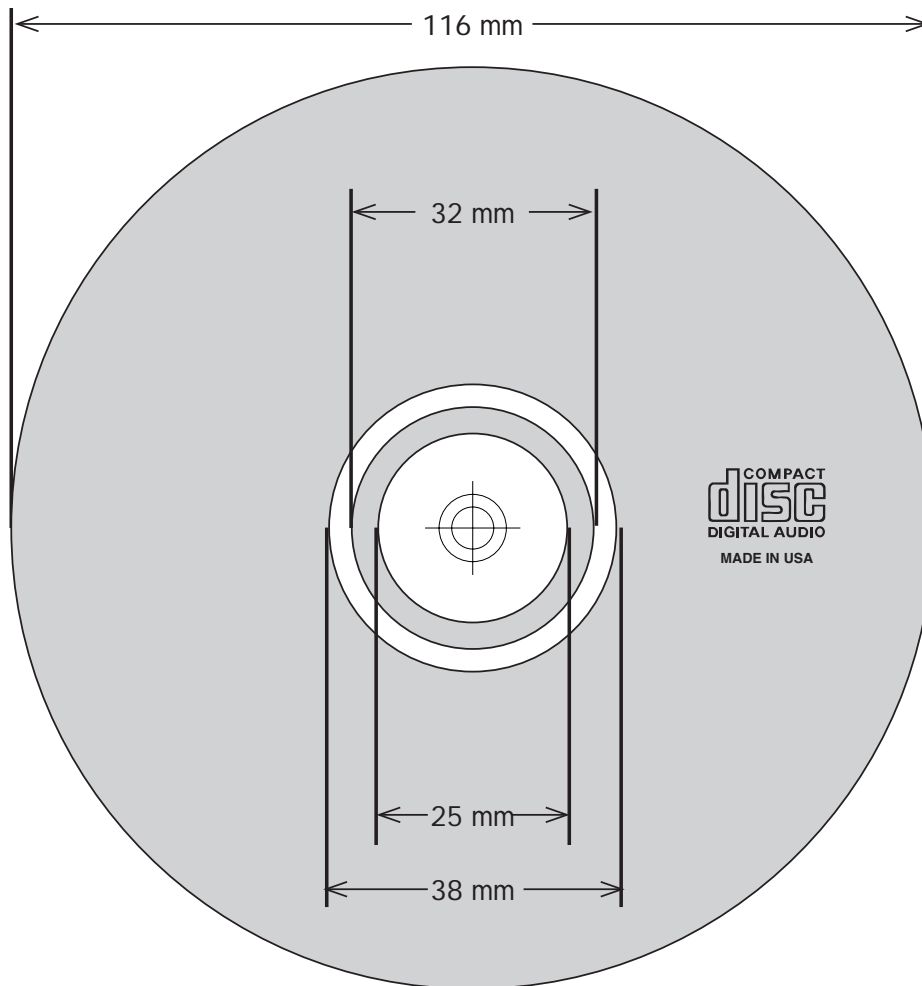

Questions? Call Disc Makers' Product Specialists at 1-800-468-9353.

**IMPORTANT NOTES:**

- Solid lines indicate trim, dotted lines are folds.
- Each document must include at least .125" bleed to ensure proper trim.  
(Except printing on CD itself.)
- Each document must have cut, fold, and registration marks.
- Keep type at least .125" from cut marks (safety margin).
- Release number must appear in each and every document.

- Drawings are not to scale!
- Measurements are in inches.

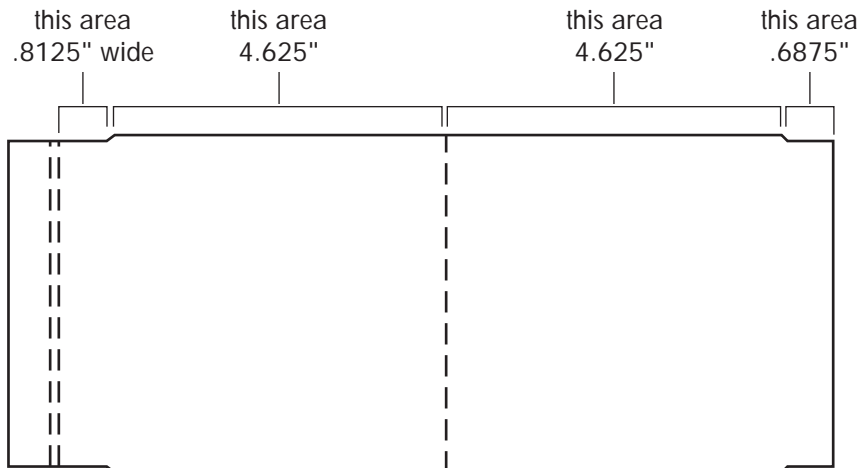
**CDV Card with Extra Panel**

**11.5" x 4.75", trim**  
(flap is .5625" wide;  
spine is .125" wide;  
die-cut edges are 4.5" high)

(11.75" x 5" includes .125" bleed  
on all sides)

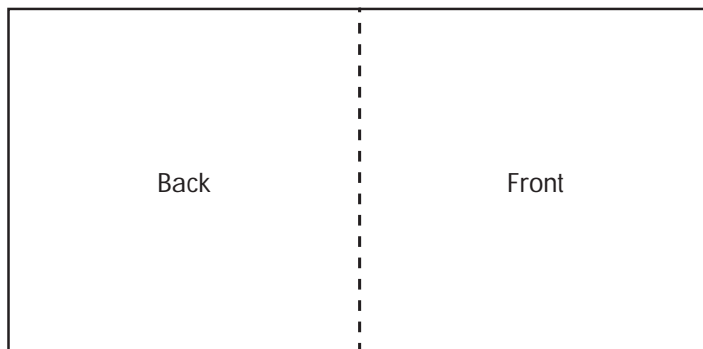
**CD Mini Jacket**

**10.125" x 5", trim**  
(each panel is 5.0625" x 5")

(10.375" x 5.25" includes  
.125" bleed top, bottom,  
and outside of panels)